

**PLEASE CHECK WWW.MOLEX.COM FOR LATEST PART INFORMATION**

**Part Number:** [0753414474](#)  
**Status:** **Active**  
**Overview:** [gbx\\_backplane\\_connector\\_system](#)  
**Description:** 1.85mm by 1.85mm (.073 by .073") Pitch 4-Pair GbX® Backplane Connector System, Power Module, 12 Circuits, 1.27µm (50µ") Gold (Au)

**Documents:**

[Drawing \(PDF\)](#) [RoHS Certificate of Compliance \(PDF\)](#)  
[Product Specification PS-75221-999 \(PDF\)](#)

**Agency Certification**

UL E29179

**General**

Product Family Backplane Connectors  
 Series [75341](#)  
 Application Backplane  
 Application Tooling Documents [Tooling Manual](http://www.molex.com/pdm_docs/ats/TM-622022099.pdf)  
 Comments Blade Length A 4.50mm, B 4.50mm, C 7.50mm, D 4.50mm  
 Component Type Power Header  
 Overview [gbx\\_backplane\\_connector\\_system](#)  
 Product Name GbX®  
 Style N/A

**Physical**

Circuits (Loaded) 8  
 Circuits (maximum) 8  
 Circuits Detail Rows A, B, C, & D  
 Color - Resin Gray  
 Durability (mating cycles max) 200  
 First Mate / Last Break Yes  
 Flammability 94V-0  
 Guide to Mating Part No  
 Keying to Mating Part None  
 Material - Plating Mating Gold  
 Material - Plating Termination Tin-Lead  
 Material - Resin High Temperature Thermoplastic  
 Number of Columns N/A  
 Number of Pairs 4  
 Number of Rows 4  
 Orientation Vertical  
 PC Tail Length (in) 0.089 In  
 PC Tail Length (mm) 2.28 mm  
 PCB Locator Yes  
 PCB Retention Yes  
 PCB Thickness Recommended (in) 0.063 In  
 PCB Thickness Recommended (mm) 1.60 mm  
 Packaging Type Tube  
 Pitch - Mating Interface (in) 0.073 In  
 Pitch - Mating Interface (mm) 1.85 mm  
 Pitch - Term. Interface (in) 0.102 In  
 Pitch - Term. Interface (mm) 2.60 mm  
 Plating min: Mating (µin) 50  
 Plating min: Mating (µm) 1.25

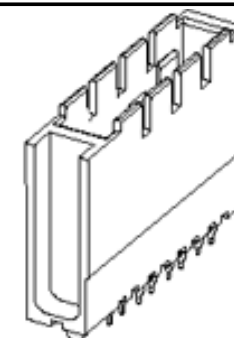

image - Reference only

Series

**EU RoHS**

**RoHS Compliant by Exemption**

**REACH SVHC**

Not Reviewed

**Halogen-Free**

Status

**Not Reviewed**

**China RoHS**

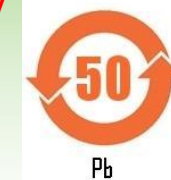

**Need more information on product environmental compliance?**

Email [productcompliance@molex.com](mailto:productcompliance@molex.com)  
 For a multiple part number RoHS Certificate of Compliance, [click here](#)

Please visit the [Contact Us](#) section for any non-product compliance questions.

**Search Parts in this Series**

[75341Series](#)

**Mates With**

[75292 GbX® Daughtercard](#)

**Application Tooling | FAQ**

*Tooling specifications and manuals are found by selecting the products below. Crimp Height Specifications are then contained in the Application Tooling Specification document.*

**Global**

Description	Product #
Insertion Module, GbX® 4 pair 1- Up Power Module	<a href="#">0622022005</a>
GbX® Single Pin Repair Tool	<a href="#">0622022090</a>
GbX® Shield Removal Tool	<a href="#">0622022100</a>

Plating min: Termination ( $\mu$ in)	30
Plating min: Termination ( $\mu$ m)	0.75
Polarized to PCB	Yes
Stackable	No
Surface Mount Compatible (SMC)	Yes
Temperature Range - Operating	-55°C to +105°C
Termination Interface: Style	Through Hole - Compliant Pin

### **Electrical**

Current - Maximum per Contact	6A
Data Rate	8.0 Gbps
Real Signals (per 25mm)	0
Shielded	No
Voltage - Maximum	120V AC (RMS)/DC

### **Material Info**

#### **Reference - Drawing Numbers**

Product Specification	PS-75221-999
Sales Drawing	SD-75341-001

GbX is a registered trademark of Amphenol Corporation.

This document was generated on 05/13/2010

**PLEASE CHECK [WWW.MOLEX.COM](http://WWW.MOLEX.COM) FOR LATEST PART INFORMATION**

10 9 8 7 6 5 4 3 2 1



NOTES:

1. MATERIALS: HOUSING - LIQUID CRYSTAL POLYMER (LCP), UL 94V-0, GRAY; CONTACT - COPPER ALLOY.
2. FINISH: SELECT GOLD IN CONTACT AREA, 50 μ" THICK; TIN/LEAD OR MATTE TIN IN COMPLIANT AREA.
3. PACKAGING PER PK-70873-562.
4. CONTACTS IN EACH ROW HAVE THE SAME WIPE LENGTH.
5. BACKPLANE ASSEMBLY MATES WITH DAUGHTERCARD POWER MODULE 75292-4\*\*\*.
6. PART SHOWN IS 75343-4467 (SHEET 4).
7. SEE OTHER SHEETS FOR ADDITIONAL NOTES.
8. WHEN INSERTING OPEN SIGNAL MODULES NEXT TO COLUMN 1 SIDE OF POWER MODULES, SIGNAL MODULES MUST BE INSERTED BEFORE THE POWERS TO AVOID INTERFERENCE BETWEEN THE TWO CONNECTOR HOUSINGS.
9. THESE PARTS CONFORM TO MOLEX PRODUCT SPECIFICATION PS-75221-999.
10. THESE PARTS CONFORM TO MOLEX COSMETIC SPECIFICATION PS-45499-002 CLASS B.

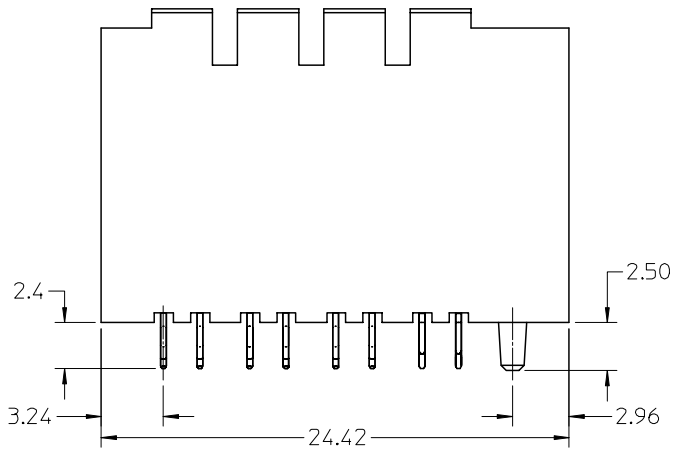

1-UP ASSEMBLY PART NUMBER

7 5 3 4 1 - A B C D  
 - TIN/LEAD PLATED PRODUCT -  
 FOR EACH ROW LOCATION A, B, C, D:  
 0 = VOID  
 4 = 4.5 mm WIPE  
 6 = 6.0 mm WIPE  
 7 = 7.5 mm WIPE  
 - LEAD-FREE PLATED PRODUCT -  
 FOR EACH ROW LOCATION A, B, C, D:  
 0 = VOID  
 2 = 4.5 mm WIPE  
 3 = 6.0 mm WIPE  
 5 = 7.5 mm WIPE

ADDED NOTES 9 & 10 EC NO: UCP2008-0426 DRAWN: C STEWART 2007/08/29 CHKD: 2007/08/30 APPR: J B INGHAM 2007/08/31	DESCRIPTION REV C	QUALITY SYMBOLS	GENERAL TOLERANCES (UNLESS SPECIFIED)	DIMENSION STYLE	SCALE	DESIGN UNITS	THIRD ANGLE PROJECTION	
		▼=0 ▽=0	mm INCH 4 PLACES ±--- ±--- 3 PLACES ±--- ±--- 2 PLACES ±--- ±--- 1 PLACE ±--- ±--- ANGULAR ±---°	MM ONLY	4:1	METRIC	DRAWN BY DATE ELO 2006/04/06 CHECKED BY DATE ELO 2005/02/22 APPROVED BY DATE CUNNINGHAM 2005/02/23 MATERIAL NO.	TITLE GBX 4 PAIR BACKPLANE POWER SALES ASSEMBLY MOLEX MOLEX INCORPORATED DOCUMENT NO.
		DRAFT WHERE APPLICABLE MUST REMAIN WITHIN DIMENSIONS	SEE CHART	THIS DRAWING CONTAINS INFORMATION THAT IS PROPRIETARY TO MOLEX INCORPORATED AND SHOULD NOT BE USED WITHOUT WRITTEN PERMISSION	SHEET NO. 1 OF 4			

9 8 7 6 5 4 3 2 1

10 9 8 7 6 5 4 3 2 1



2-UP ASSEMBLY PART NUMBER

7 5 3 4 2 - A B C D

- TIN/LEAD PLATED PRODUCT -  
FOR EACH ROW LOCATION A, B, C, D:

- 0 = VOID
- 4 = 4.5 mm WIPE
- 6 = 6.0 mm WIPE
- 7 = 7.5 mm WIPE

- LEAD-FREE PLATED PRODUCT -  
FOR EACH ROW LOCATION A, B, C, D:

- 0 = VOID
- 2 = 4.5 mm WIPE
- 3 = 6.0 mm WIPE
- 5 = 7.5 mm WIPE



SEE SHEET 1 FOR ADDITIONAL INFORMATION  
CHECK WITH PRODUCT MANAGER FOR AVAILABILITY

SEE SHEET ONE EC NO: UCP2008-0426 DRW: JSTEWART 2007/08/29 CHKD: 2007/08/30 APPR: J. INGHAM 2007/08/31	QUALITY SYMBOLS ▽=0 ▽=0	GENERAL TOLERANCES (UNLESS SPECIFIED)		DIMENSION STYLE MM ONLY	SCALE 4:1	DESIGN UNITS METRIC	THIRD ANGLE PROJECTION		
				mm	INCH	DRAWN BY ELO	DATE 2006/04/06	TITLE GBX 4 PAIR BACKPLANE POWER SALES ASSEMBLY	
		4 PLACES	±----	±----	CHECKED BY ELO	DATE 2005/02/22	MOLEX INCORPORATED		
		3 PLACES	±----	±----	APPROVED BY CUNNINGHAM	DATE 2005/02/23			
2 PLACES	±----	±----	ANGULAR ±---°		MATERIAL NO. SEE CHART	DOCUMENT NO. SD-75341-001	SHEET NO. 2 OF 4		
1 PLACE	±----	±----	DRAFT WHERE APPLICABLE MUST REMAIN WITHIN DIMENSIONS		THIS DRAWING CONTAINS INFORMATION THAT IS PROPRIETARY TO MOLEX INCORPORATED AND SHOULD NOT BE USED WITHOUT WRITTEN PERMISSION				

9 8 7 6 5 4 3 2 1



COLUMN 1  
 COLUMN 2  
 COLUMN 3  
 COLUMN 4  
 COLUMN 5  
 COLUMN 6

3-UP ASSEMBLY PART NUMBER

7 5 3 4 3 - A B C D  
 - TIN/LEAD PLATED PRODUCT -  
 FOR EACH ROW LOCATION A, B, C, D:  
 0 = VOID  
 4 = 4.5 mm WIPE  
 6 = 6.0 mm WIPE  
 7 = 7.5 mm WIPE  
 - LEAD-FREE PLATED PRODUCT -  
 FOR EACH ROW LOCATION A, B, C, D:  
 0 = VOID  
 2 = 4.5 mm WIPE  
 3 = 6.0 mm WIPE  
 5 = 7.5 mm WIPE

SEE NOTE 4.

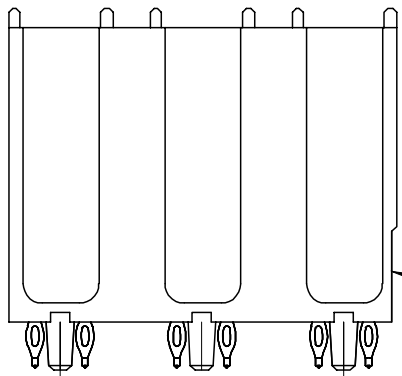
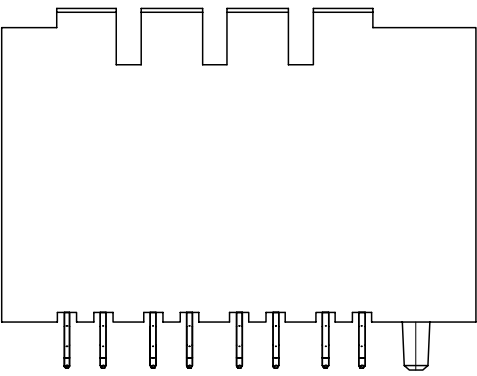

SEE NOTE 8.

14.80

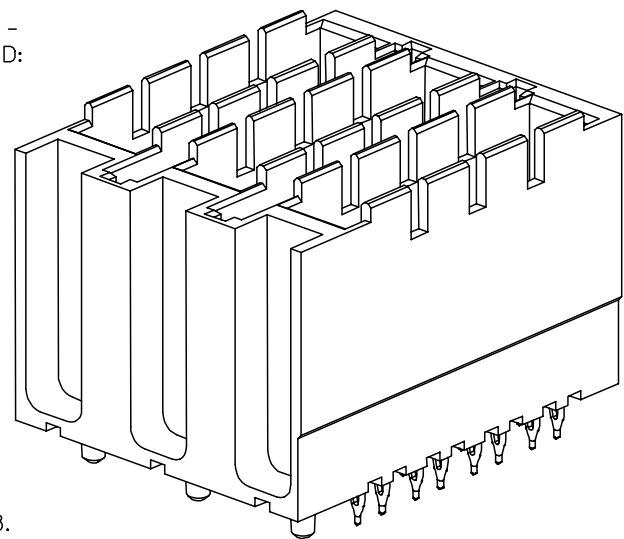

SEE SHEET 1 FOR ADDITIONAL INFORMATION  
 CHECK WITH PRODUCT MANAGER FOR AVAILABILITY

SEE SHEET ONE EC NO: UCP2008-0426 DRWN: C STEWART 2007/08/29 CHKD: 2007/08/30 APPR: J BINGHAM 2007/08/31	QUALITY SYMBOLS ▽=0 ▽=0	GENERAL TOLERANCES (UNLESS SPECIFIED)		DIMENSION STYLE MM ONLY		SCALE 4:1	DESIGN UNITS METRIC	THIRD ANGLE PROJECTION	
			mm	INCH	DRAWN BY ELO	DATE 2006/04/06	TITLE GBX 4 PAIR BACKPLANE POWER SALES ASSEMBLY		
		4 PLACES ± --- ± ---	3 PLACES ± --- ± ---	2 PLACES ± --- ± ---	CHECKED BY ELO	DATE 2005/02/22	MOLEX INCORPORATED		
		1 PLACE ± --- ± ---	ANGULAR ± ---°		APPROVED BY CUNNINGHAM	DATE 2005/02/23	MATERIAL NO. SEE CHART	DOCUMENT NO. SD-75341-001	SHEET NO. 3 OF 4
DRAFT WHERE APPLICABLE MUST REMAIN WITHIN DIMENSIONS			THIS DRAWING CONTAINS INFORMATION THAT IS PROPRIETARY TO MOLEX INCORPORATED AND SHOULD NOT BE USED WITHOUT WRITTEN PERMISSION						

10 9 8 7 6 5 4 3 2 1

SEE NOTE 5.

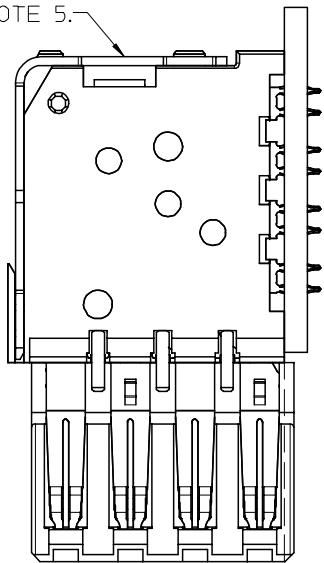

6.0 mm WIPE  
7.5 mm WIPE  
4.5 mm WIPE

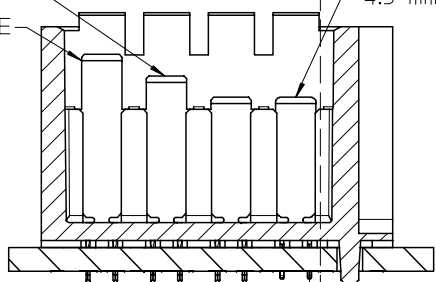

0.76  
DC BOARD EDGE TO  
CENTERLINE OF BP TAIL

0.15

### HOLE PATTERN FOR 1-UP ASSEMBLY

- 1.) ADD 7.40 FROM CENTERLINES OF PEGS FOR MULTIPLE UP ASSEMBLIES.
- 2.) ADD 5.55 FROM CENTERLINE TO CENTERLINE OF PEG FOR INDIVIDUAL POWER MODULES STACKED NEXT TO EACH OTHER.

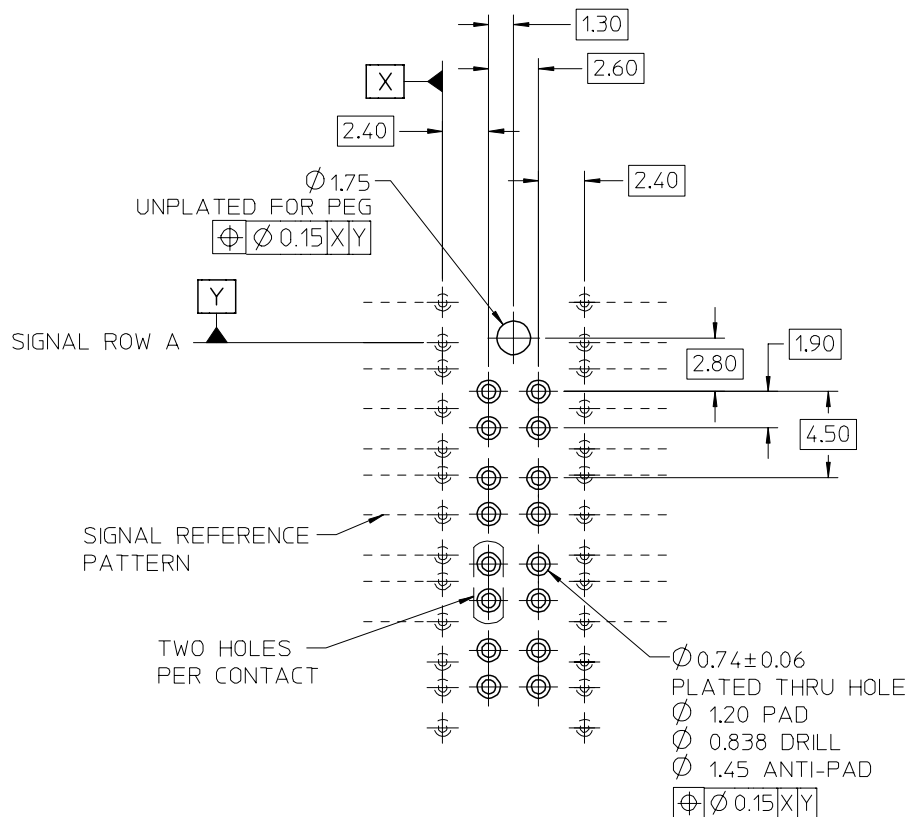

ADDED $\phi 0.74 \pm 0.06$ EC NO: UCP2008-0426 DRWN: C STEWART 2007/08/29 CHKD: J BINGHAM 2007/08/30 APPR: J BINGHAM 2007/08/31	QUALITY SYMBOLS $\nabla = 0$ $\nabla = 0$	GENERAL TOLERANCES (UNLESS SPECIFIED)		DIMENSION STYLE MM ONLY		SCALE 4:1	DESIGN UNITS METRIC	THIRD ANGLE PROJECTION																	
		<table border="1"> <thead> <tr> <th></th> <th>mm</th> <th>INCH</th> </tr> </thead> <tbody> <tr> <td>4 PLACES</td> <td>± ---</td> <td>± ---</td> </tr> <tr> <td>3 PLACES</td> <td>± ---</td> <td>± ---</td> </tr> <tr> <td>2 PLACES</td> <td>± ---</td> <td>± ---</td> </tr> <tr> <td>1 PLACE</td> <td>± ---</td> <td>± ---</td> </tr> </tbody> </table>			mm	INCH	4 PLACES	± ---	± ---	3 PLACES	± ---	± ---	2 PLACES	± ---	± ---	1 PLACE	± ---	± ---	DRAWN BY ELO 2006/04/06		TITLE GBX 4 PAIR BACKPLANE POWER SALES ASSEMBLY				
			mm	INCH																					
		4 PLACES	± ---	± ---																					
3 PLACES	± ---	± ---																							
2 PLACES	± ---	± ---																							
1 PLACE	± ---	± ---																							
CHECKED BY ELO 2005/02/22		APPROVED BY CUNNINGHAM 2005/02/23		Molex MOLEX INCORPORATED																					
ANGULAR ± --- °		DRAFT WHERE APPLICABLE MUST REMAIN WITHIN DIMENSIONS		MATERIAL NO. SEE PREVIOUS		DOCUMENT NO. SD-75341-001		SHEET NO. 4 OF 4																	

9 8 7 6 5 4 3 2 1